

# **POWERSTAR Potable Water Truck**

## **User's Manual**



**POWERSTAR TRUCKS INDUSTRY CO., LIMITED**

**<http://www.isuzutrucks.cn.com/>**

## Preface

Thank you for purchasing POWERSTAR products. For better using your ISUZU potable water truck, get the best operating performance, we strongly suggest that before the operation process you could read this manual instructions carefully, and to manipulate the program handily.

The manual detailed describes the performance of potable water truck, structure, usage, precautions and maintenance of such knowledge. While showing details of the truck, both pictures and description will together help you get better understanding of how to use truck. Before the operation, the skilled operator should carefully read the contents of the manual.

After master the truck performance characteristics, methods of operation and precautions, then could start to operate this water truck. In order to ensure the staff turnover after the operation, and properly use of the truck. This manual book must be properly kept, shall not be lost and damage.

----POWERSTAR TRUCKS



WERSTAR

POWERSTAR

## Contents

Chapter 1. General Description .....	4
Chapter 2, Main Technical Data.....	5
Chapter 3, Potable Water Truck Components .....	6
i ,Potable Water Truck Structure Components .....	6
Chapter 4, Potable Water Truck Working Principles .....	9
i ,How are the water tank trucks working?.....	9
ii ,What is the main component for truck? .....	9
iii, How to operate potable water truck Water Pump System?. (Very Important).....	10
Chapter 5, Others for Attention .....	17
i ,Precautions for Use.....	17
ii ,Regular Maintenance.....	17
iii ,Truck Maintenance Schedule.....	18

## Chapter 1. General Description

*POWERSTAR TRUCKS Potable Water Truck based on type II ISUZU 4\*2 classical ELF chassis, water tanker capacity could up to 9,000liters, mainly used for water storage and delivery work, the working aerial can be city street, factory, community and other areas of need.*

*The vehicle designed to fully rely on the advantages of the original ISUZU 4\*2 LHD chassis, fully consider the product's convenience and reliability. The water truck equipped with stainless steel water pump for regular use. The water tanker material is food grade stainless steel, which can be durable and service for a long time. As for tank capacity, this can be up to 9 CBM, with one manhole on top, at rear of the truck equipped with 6 fast delivery nozzles for easy operation, and can cover all customers' water delivery requirement.*

*The ISUZU 4\*2 Potable Water Truck equipped with rear climbing ladder, side & rear guard plate, six fast water delivery nozzles to help better use of the trucks. Two sides equipped with Therefore, the vehicle is an ideal Water Tank Truck mainly for water transportation and water spraying.*



**(Preview for your ISUZU 9,000L Potable Water Trucks)**

## Chapter 2, Main Technical Data

### Basic parameter:

Items		9CBM ISUZU Potable Water Truck
Outer Dimension (L×W×H) (mm)		7650*2200*2400
Wheelbase (mm)		4475
Kerb Weight (kg)		5200
G E A R	Gearbox brand	MLD
	Model	6-shift gearbox
	Type	Manual
Cab capacity (includes driver)		2+1
E N G I N	Model	4HK1-TCG40
	Type	Four cylinder inline, four stroke, water-cool, turbocharged Inter-cooling, diesel
	Rating Power (kW/HP)	139/190
	Emission Standard	Euro 4

Note: 1. The vehicle height includes rear climb ladder.

2. We keep the right to revise the parameters on the list above.

### Water Tanker basic parameter list

Items		Parameter	
Water tanker	Capacity (CBM)	4	
	Material	Food grade stainless steel	
	Painting	Internal	Non
		External	White painting as required
	Special Equipment	Manhole	Equipped on top of tank
		Valves	Equipped on side & rear of tank
Climbing Ladder		Equipped at rear of tank	
Water Pump	Brand	Famous China brand stainless steel pump	
	Model	65SZB-40/45	
	Water Flow Rate	m <sup>3</sup> /h	40
		l/min	667
	Lifting (m)	45	
	Self-Suction Height (m)	6.5	
	Self-Suction Capacity (min/4m)	1	
	Rated Power (kw)	7.5	
More details for Water Pump showing as below			

## Chapter 3, Potable Water Truck Components

### i ,Potable Water Truck Structure Components

Overview for ISUZU 4\*2 potable water truck technical drawing:

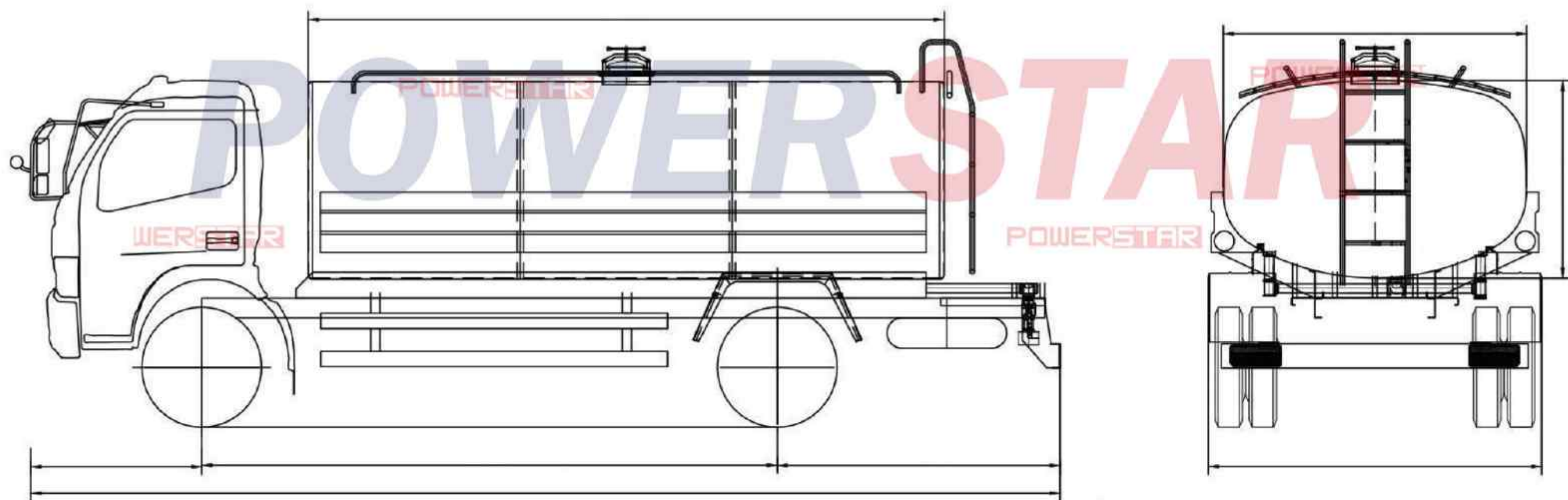

(Picture 1)

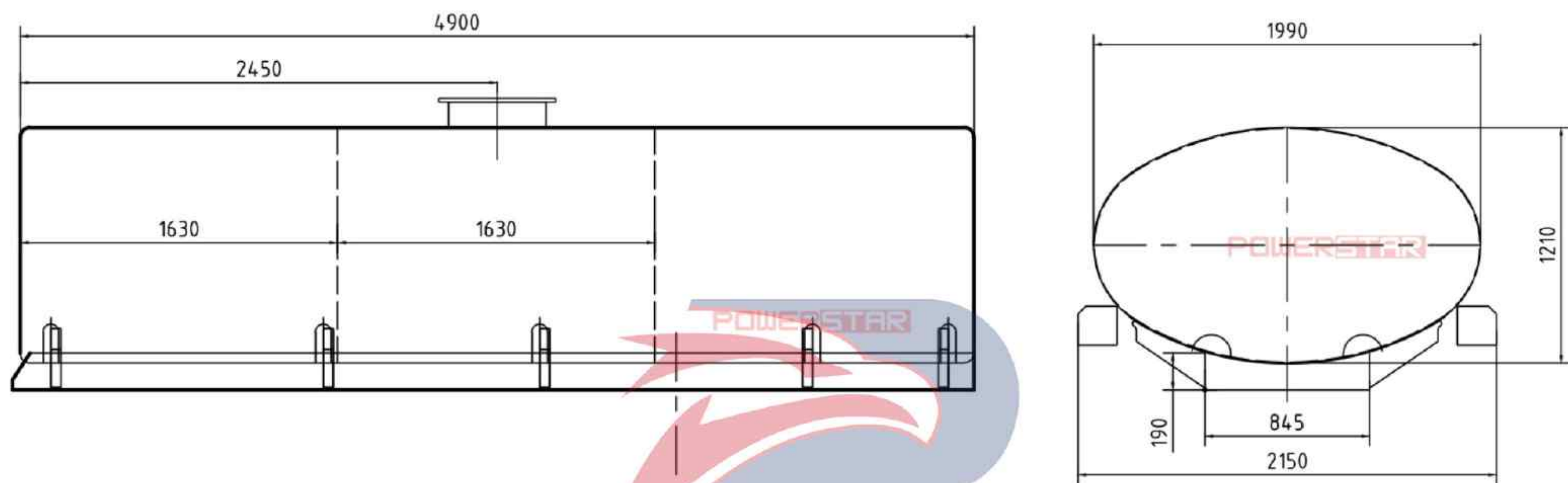

(Picture 2)

Above picture 1 drawing show the potable water truck dimension for reference; the tanker has one stainless steel material manhole for easy maintenance, on driver side equipped with stainless steel water pump and valves. At rear equipped with six units nozzles for water delivery working.

Picture 2 showing that the whole water tank is **oval shape**; with tanker capacity is 9,000 liters:

Top of the Tank: Stainless steel manhole and safety fence



Rear of the Tank: Climbing ladder, water discharging nozzles, safety lamp and water level indicator.

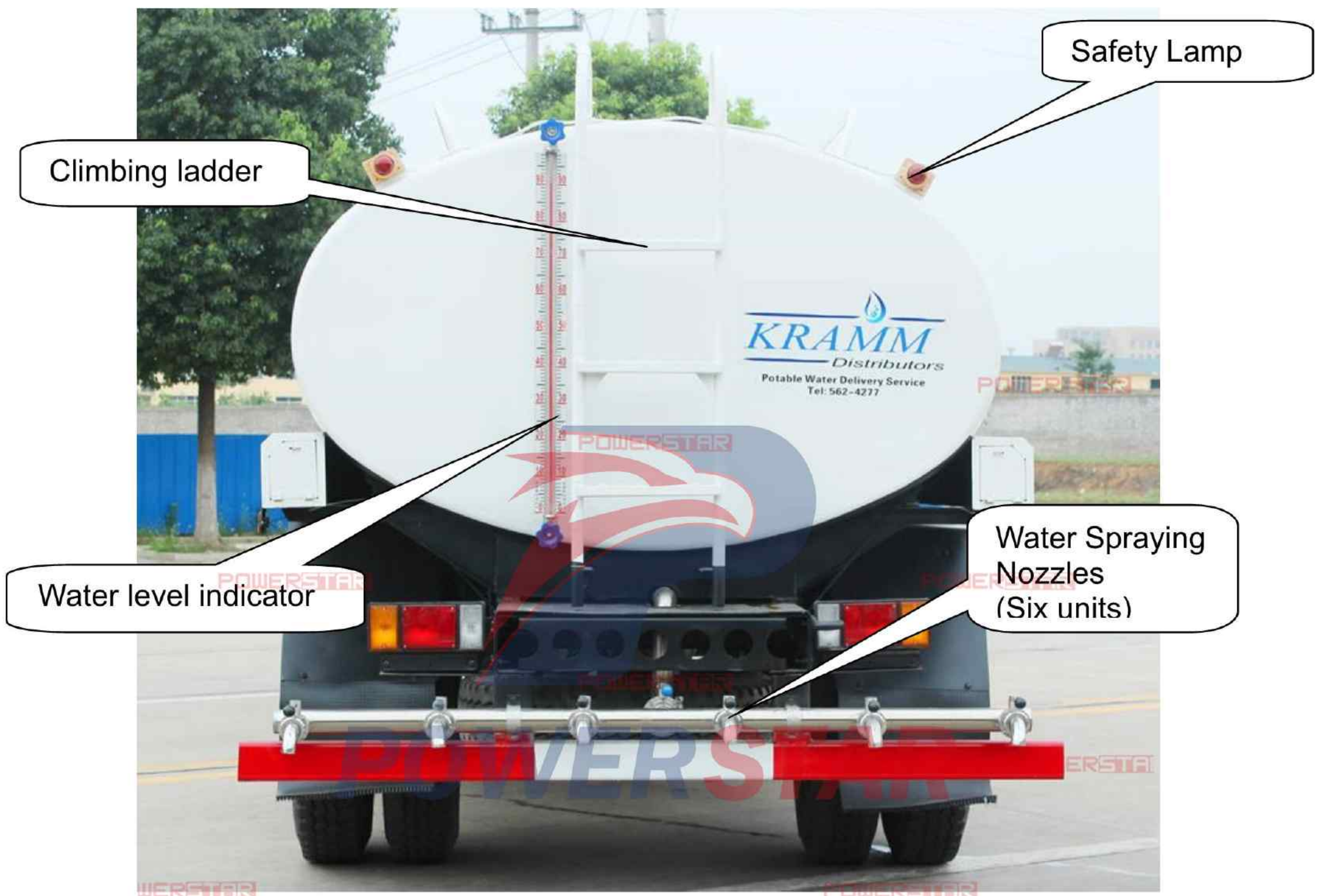

Left side of the Tank (Driver side): Water pump system, pipeline storage box and Safety fence

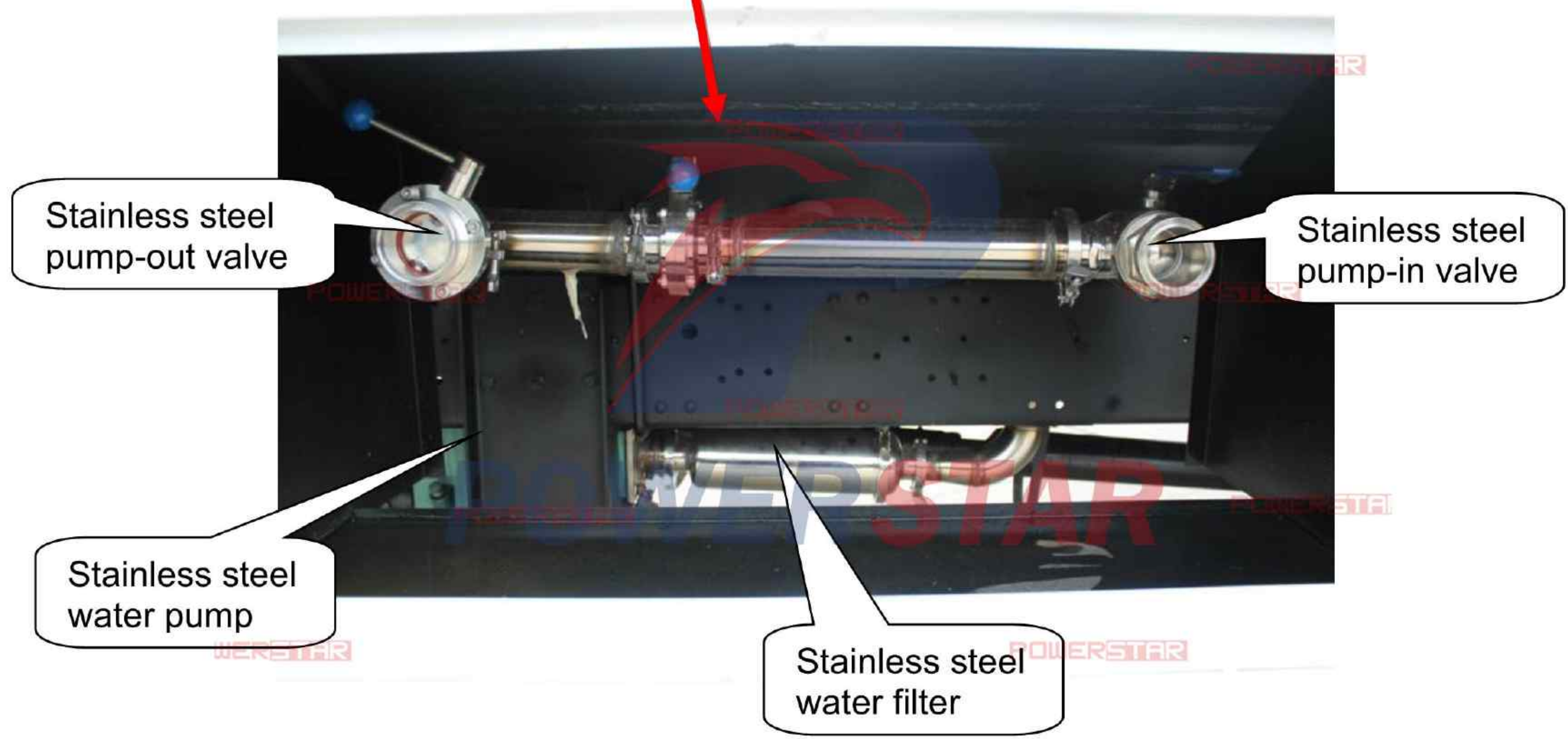
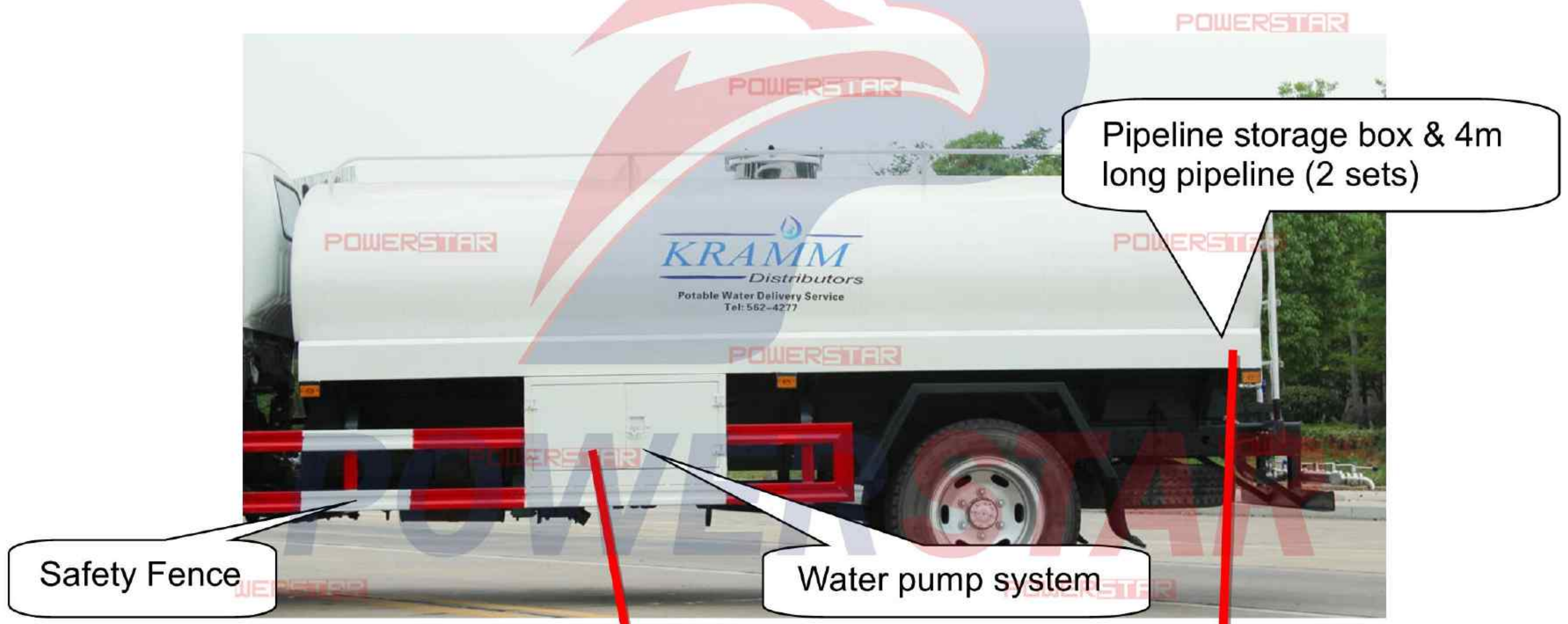



## Chapter 4, Potable Water Truck Working Principles

The operator should fully understand Whole Structure and Working Principle for ISUZU 4\*2 Potable Water Truck before any operation. Only trained person can operate this vehicle properly and to prevent unnecessary accidents and equipment damage.

### i ,How are the water tank trucks working?

Water Pump system makes use of the special power take off (PTO) to get power from the engine, and then pass the power to the 65SZB-40/45 stainless steel water pump via drive axle so to rotate the water pump. The pump, pipelines valves and joints consist of the pipeline system. Turn on/off valves through the regulated program, the pump can absorb water into the tank from the source or exhaust the water inside the tank through the set lines, and then come to all function.

### ii ,What is the main component for truck?

The water tank truck is refitted based on the ISUZU LHD 4\*2 chassis. The refit part includes water carrying assembly, actuator device, pipeline system and operation system.

- Water carrying assembly: A food grade stainless steel container shaped ellipse, which is used to store potable water.
- Actuator device: includes power take off, drive line, etc., which can pass the power from the chassis to the stainless steel water pump.
- Pipeline system helps come to all special functions, including water pump system front and rear water discharging nozzles.
- Operation system: helps come to all special functions' convert.

iii, How to operate potable water truck Water Pump System?. **(Very Important)**

1. Refer to Chapter 3 and get more information about valves structure component.

**Please Note: When wrench is PARALLEL with pipeline, the pipe flow;  
When wrench is VERTICAL with pipeline, the pipe closed.**

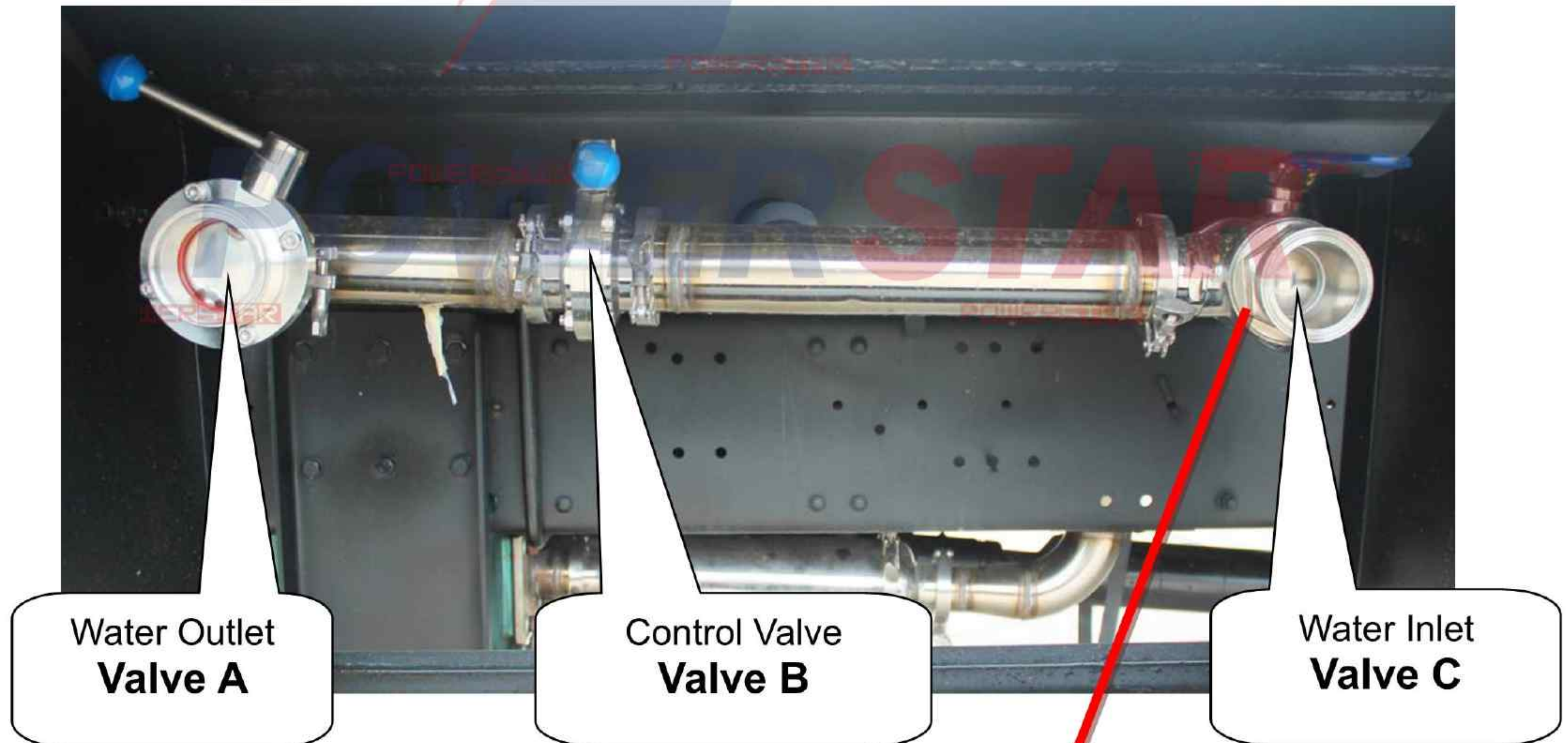

(Valve 3)

2. Start the truck engine, pressure the clutch pedal, with Gearbox to Neutral, and then operate the PTO accelerator joystick to UPPER POSITION, finally release the pedal slowly.

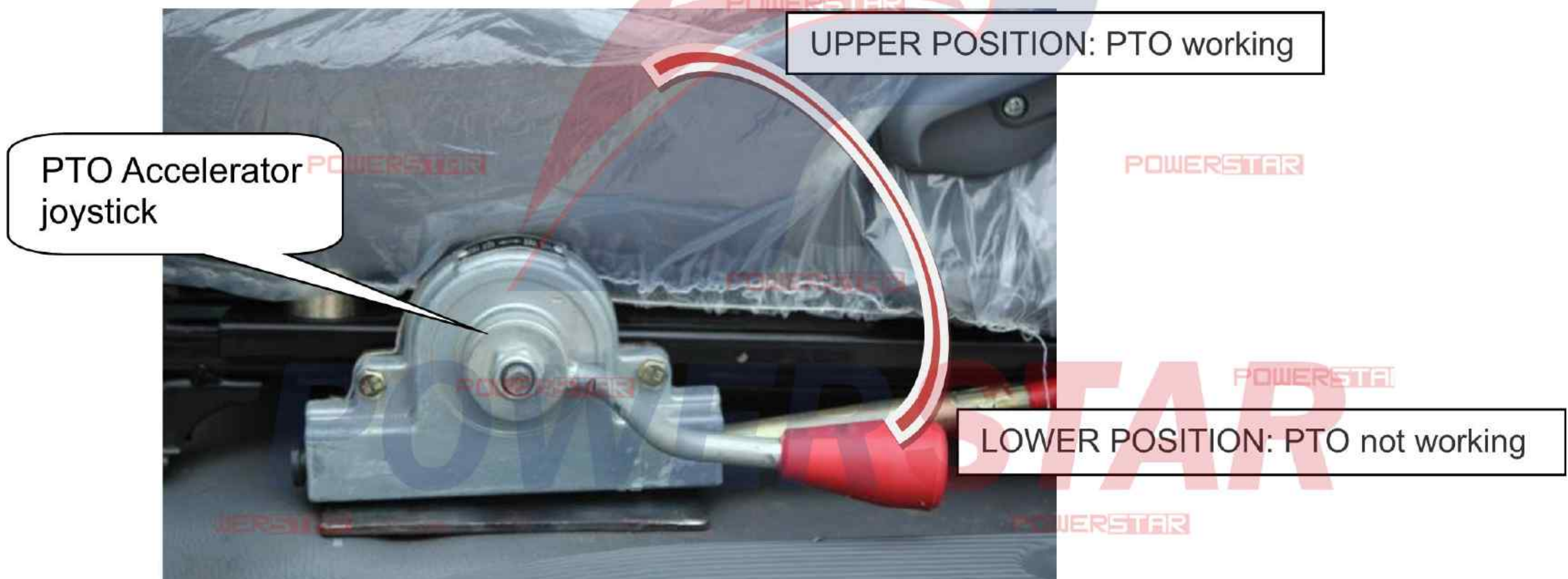

3. Carefully operate the potable water truck as below:

- a) Before operating valves you should operating the power take off (PTO), which showing as step 2 above
- b) If this is **First Time to suction water**: You should injection at least 20Liters water into the water tank. Open the manhole cover and connect the tubes, then operation the Power Take Off and make pump working. Nearly 2 minutes later, when air exhaust out, the pump can start suction water normally.



c) Special function operation showing as below, which mainly has following four functions:

- **Water pumping into the tank:** close **Valve A**, open **Valve B**, **Valve C** (Open 1 & 3, Close 2), connect the pipeline with Valve C, the other side of pipeline be in potable water storage box. then the pump start working and water go into the tank through Valve C, details showing as below chart.

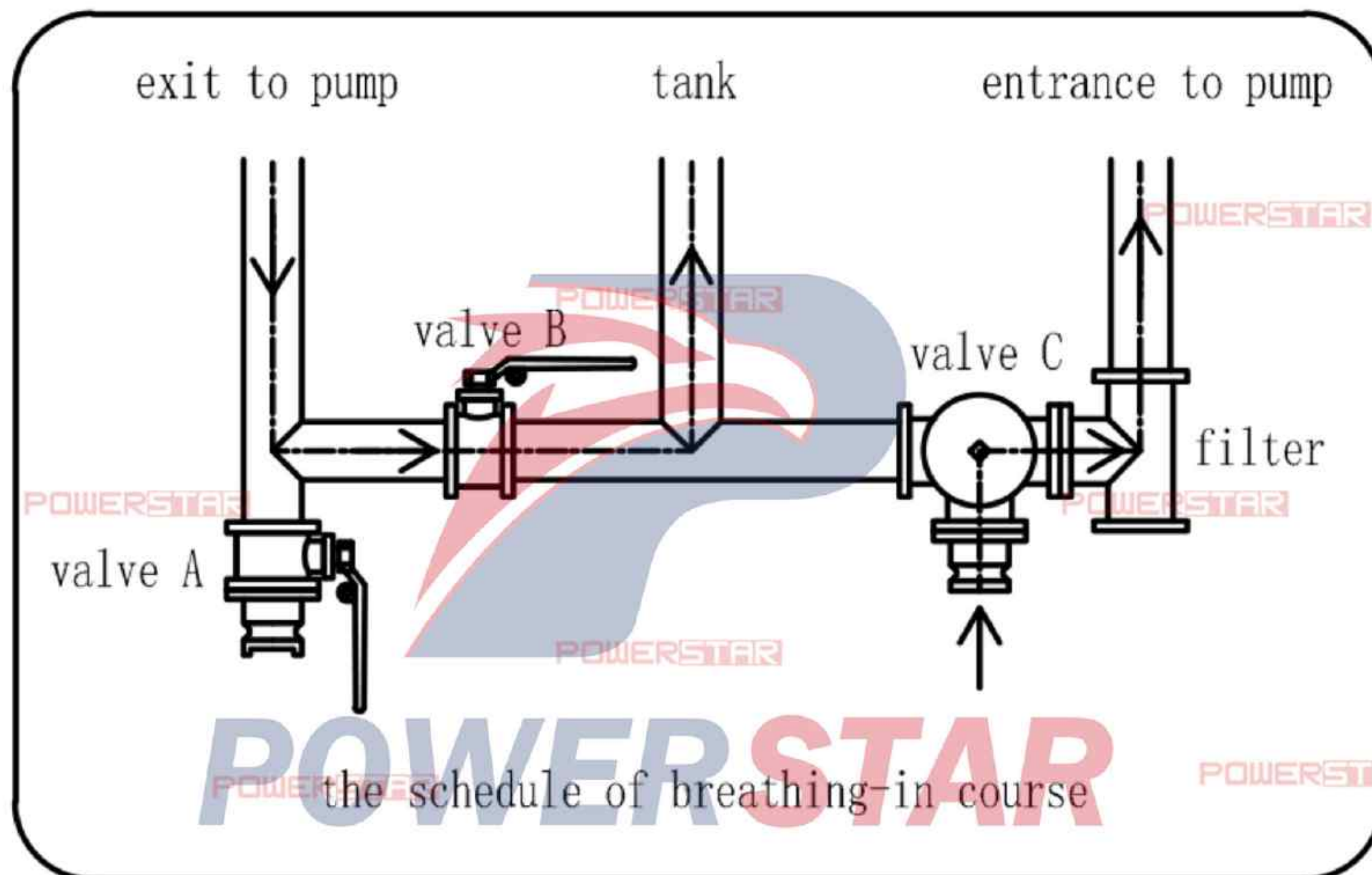
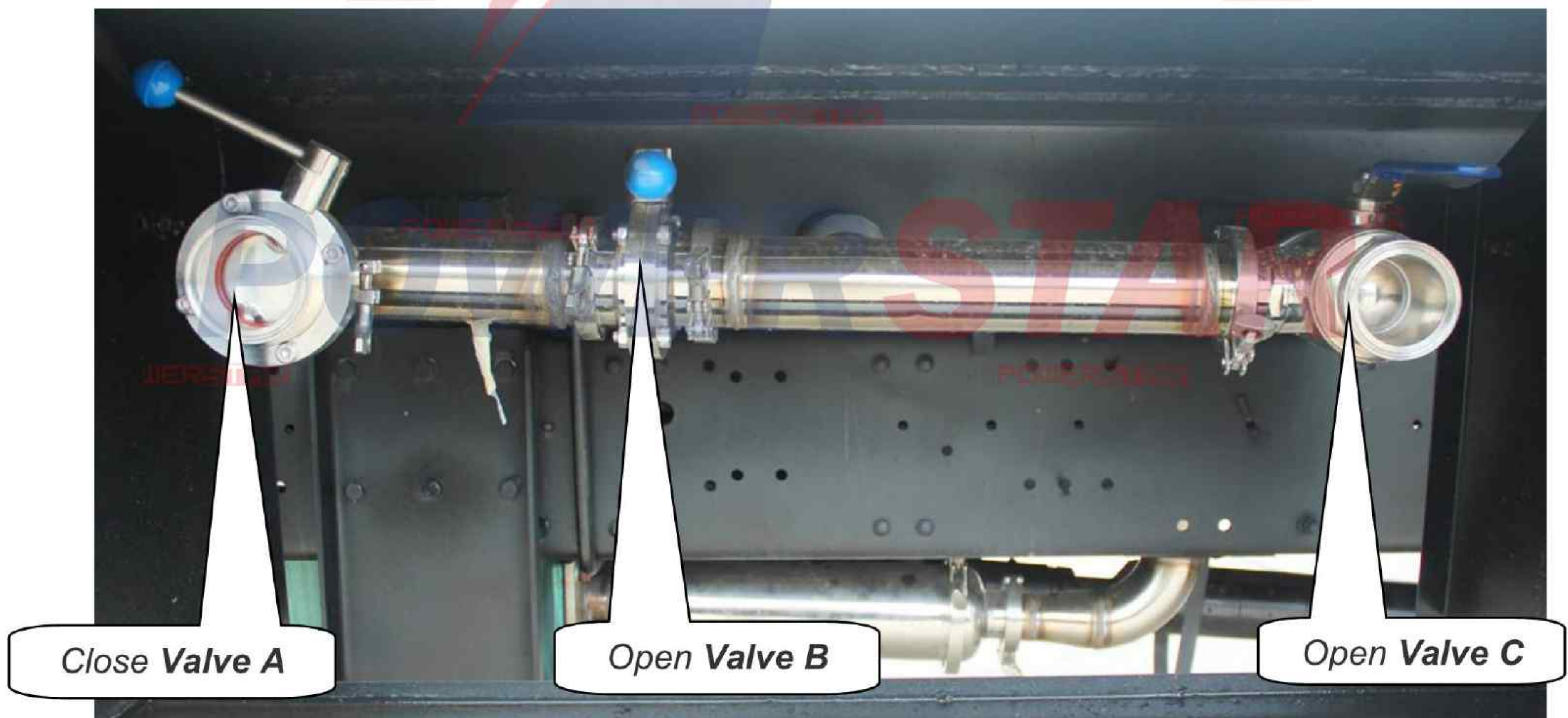

(Pump-In Process Working principle)

- **Water pumping out of the tank:** open Valve A, close Valve B, Valve C (Open 2 & 3, Close 1), then the pump start working and water go out of the tank through Outlet Valve A, details showing as below chart.

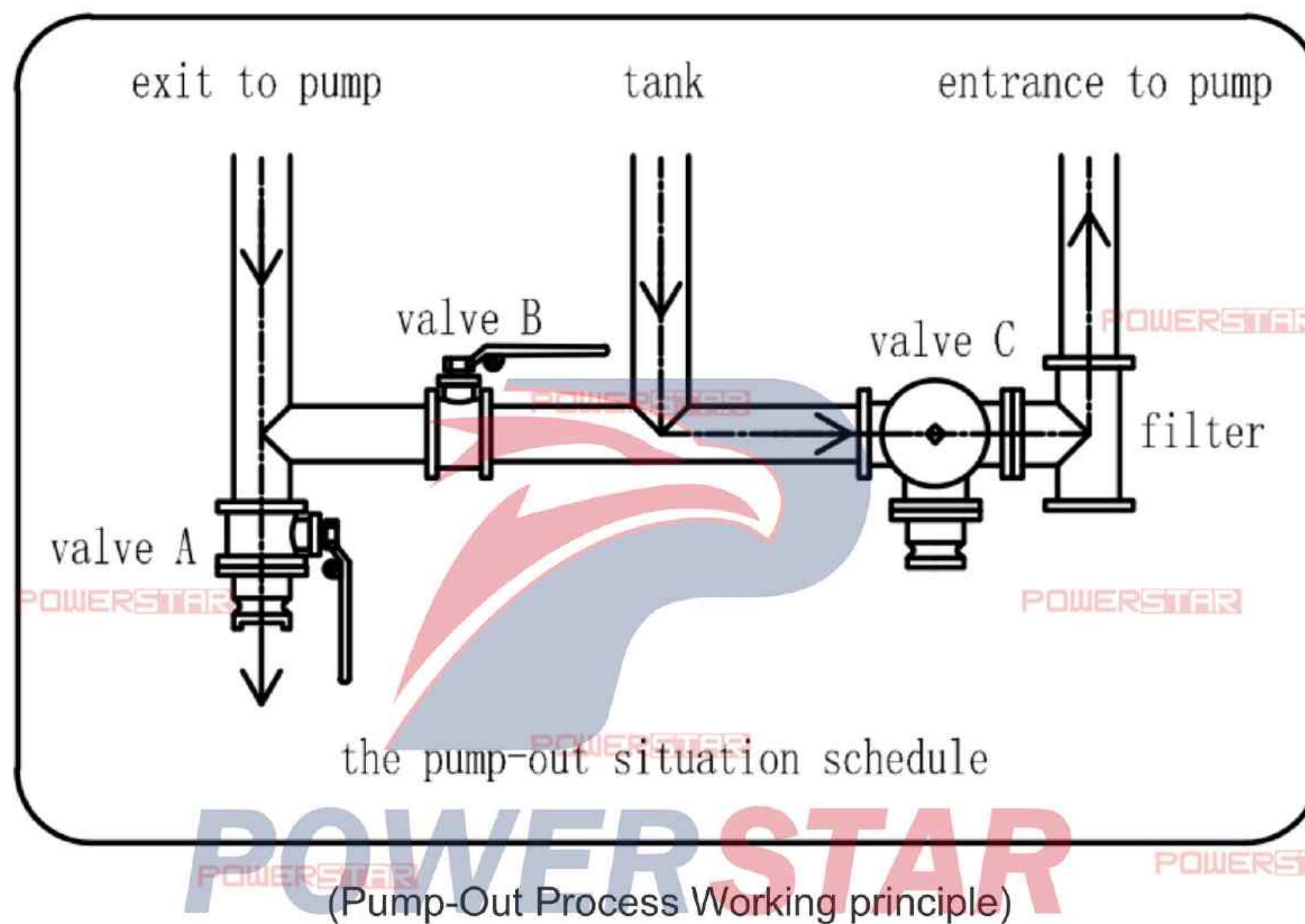
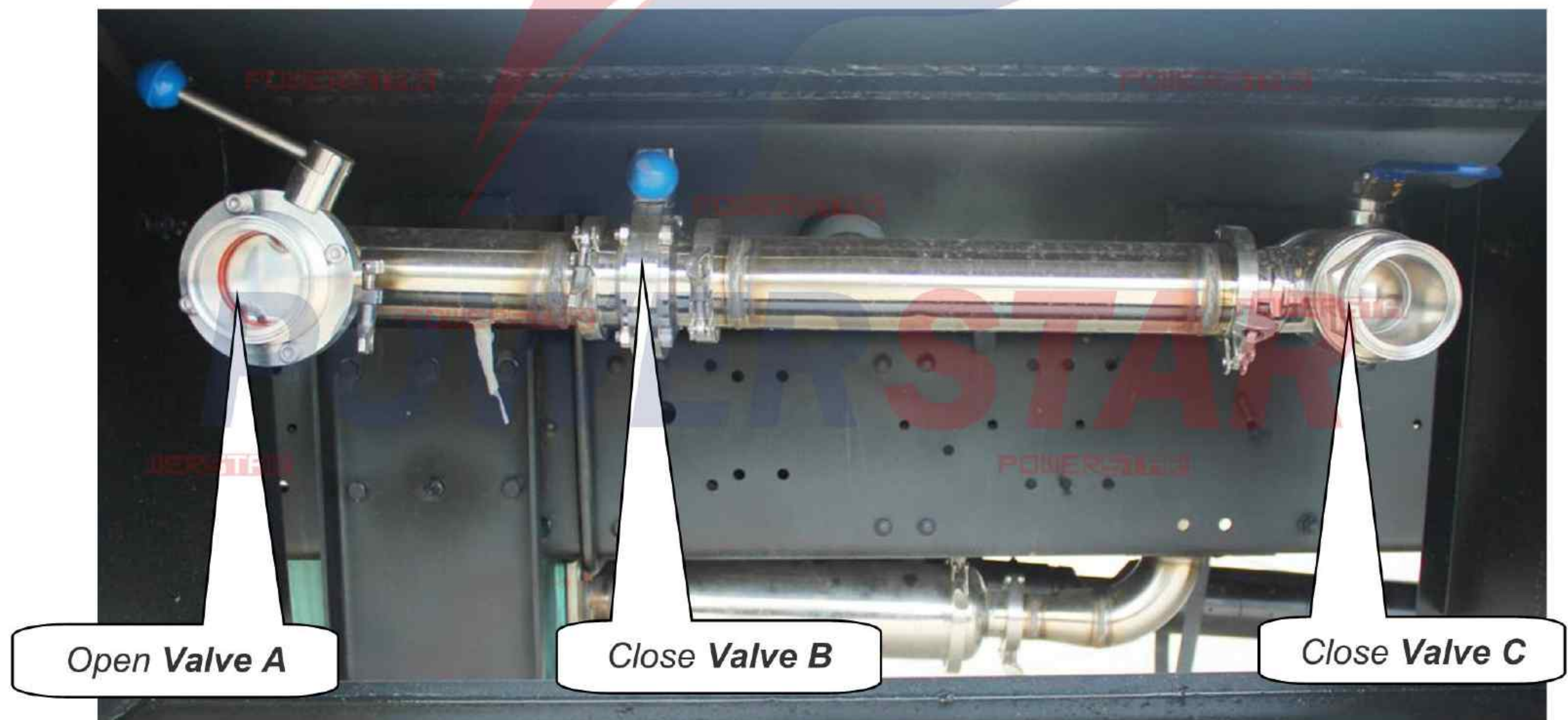

- **Water flowing out of the tank automatically (Water Pump does not work):** Valve C (Close 1 & 2 & 3), open Valve A & Valve B, then the water flow out of the tank automatically by self-gravity, details showing as below chart.

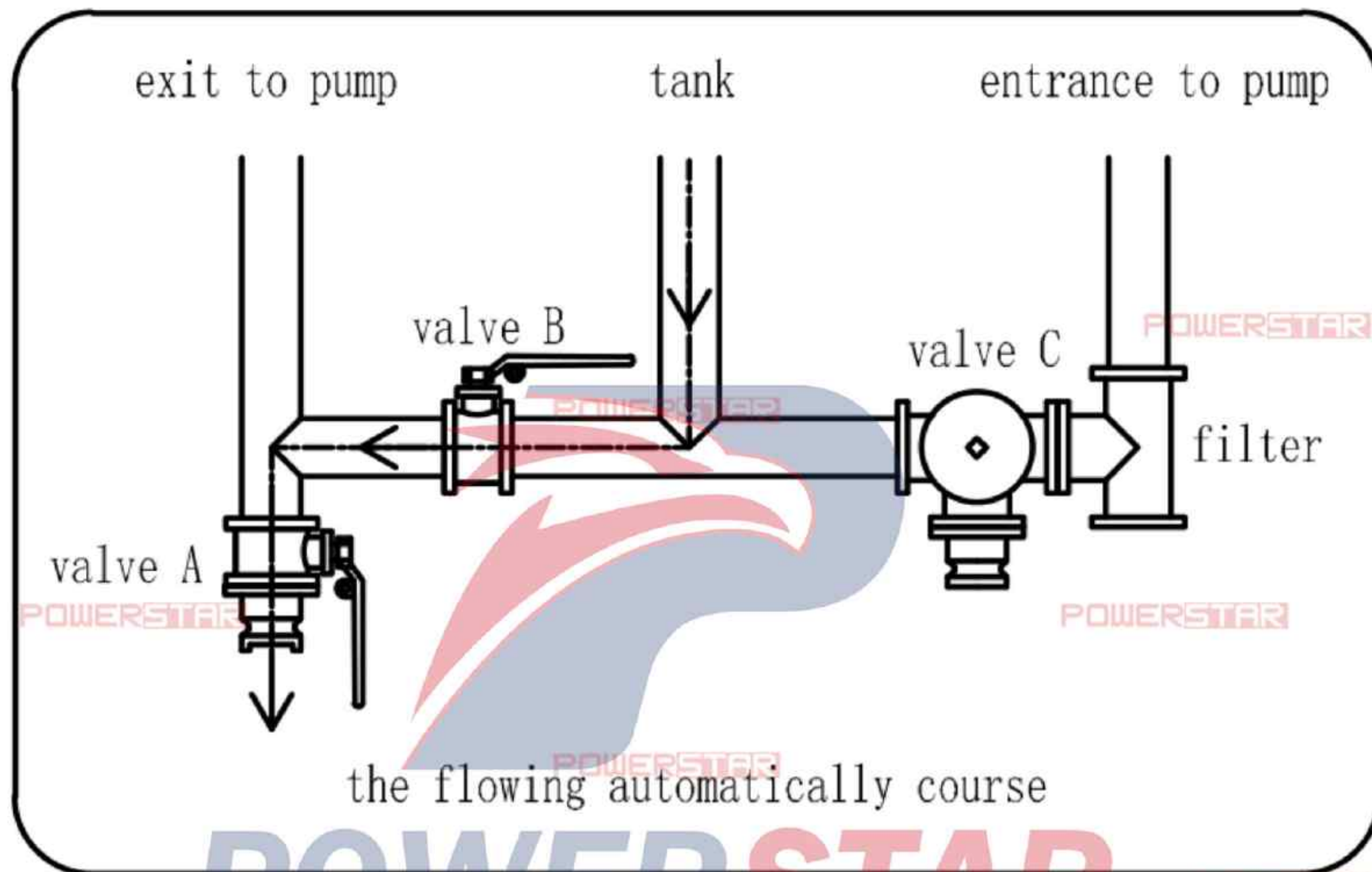
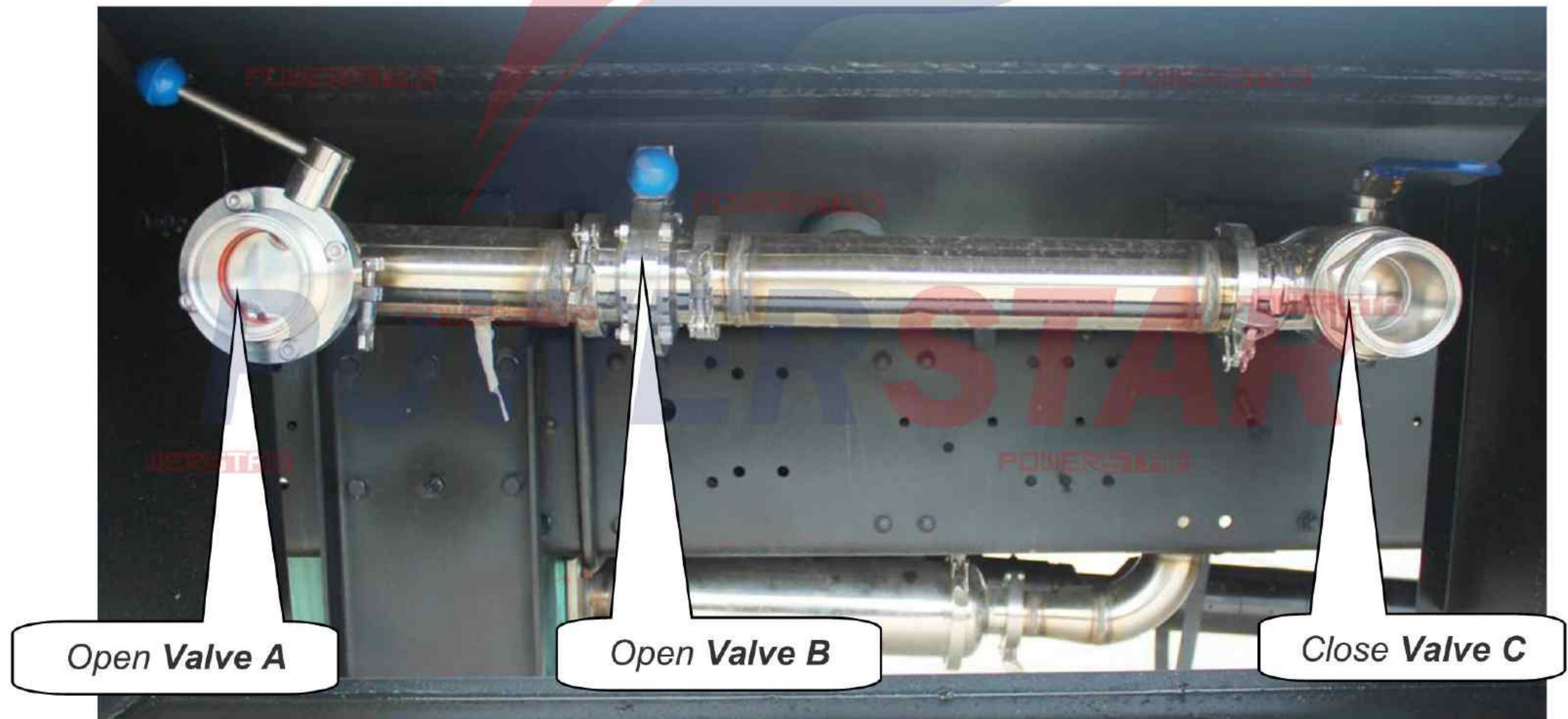

(Flowing Automatically Process Working principle)

- **Water pumping out of the tank (Pump out from rear Valves):** close Valve A, Valve B & Valve C (Close1, Open 2 & 3),, then the pump start working and water pumping out of the tank, and finally spraying through rear Valves 1~6 (The Valves 1~6 can be controlled separated), details showing as below chart.

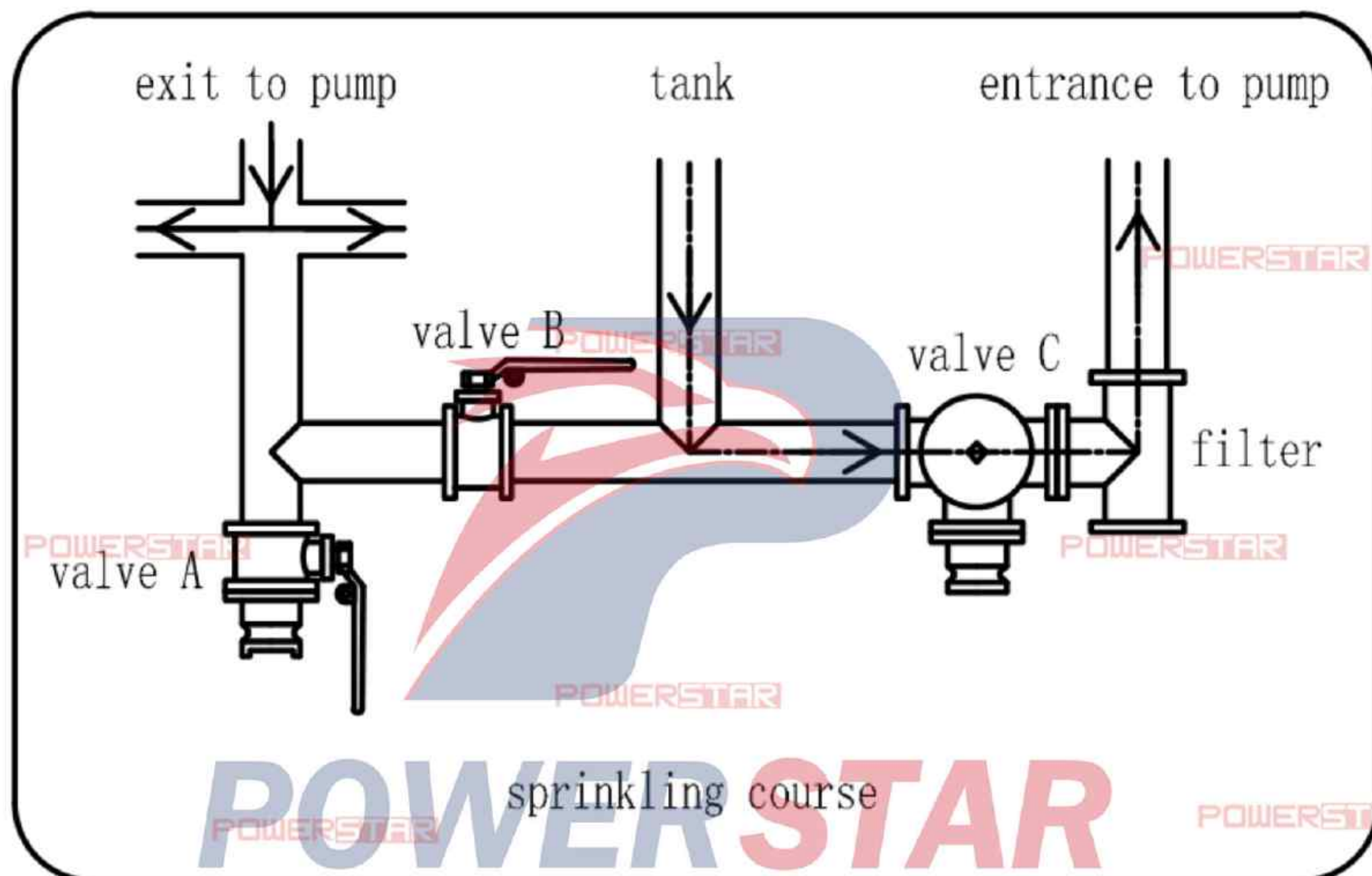
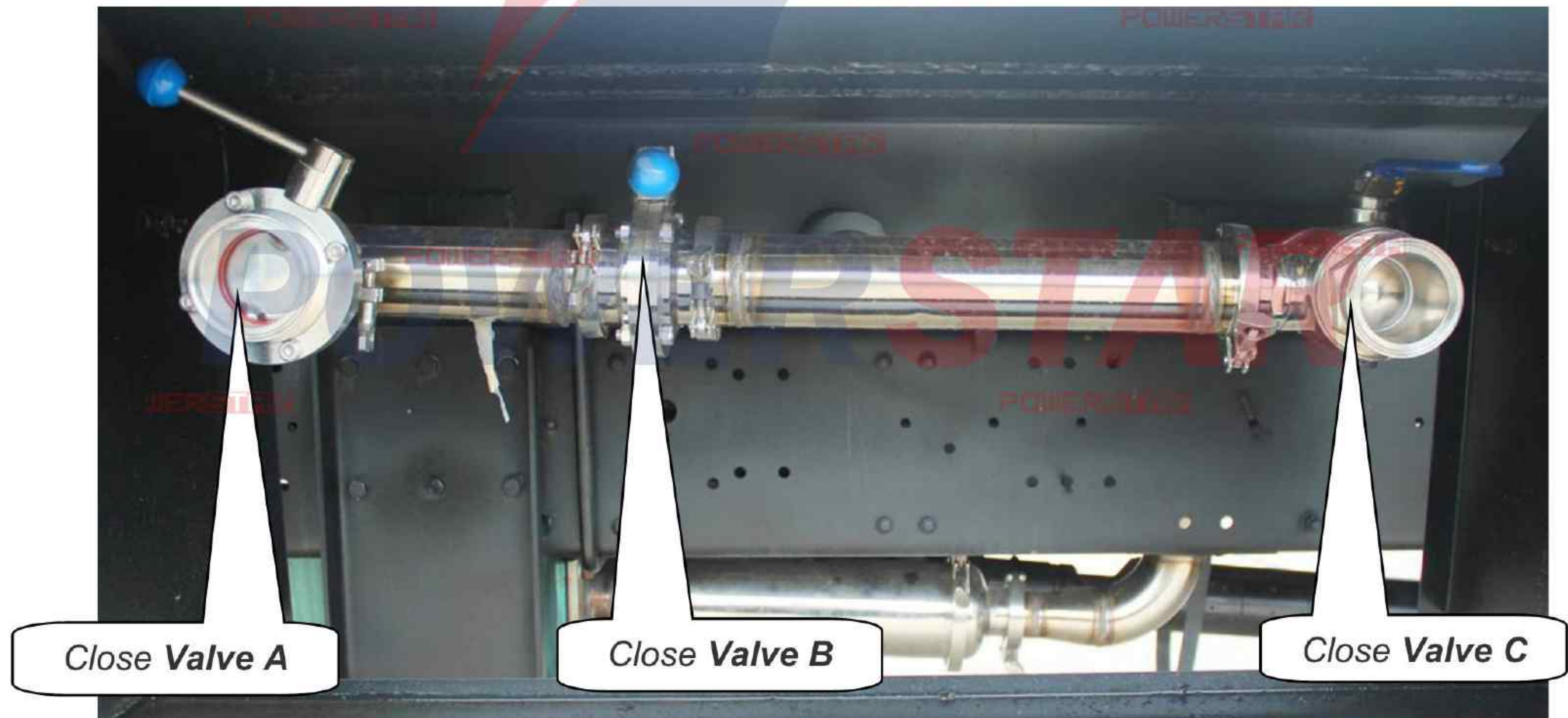

(Pump-Out Process Working principle)

**Make sure at least one Nozzle keeps open before operating the sprinkling course.**

**PLEASE NOTE: Each Nozzle Has One Control Valve for Easy Operation**

**Rear Nozzles for potable water delivery:**

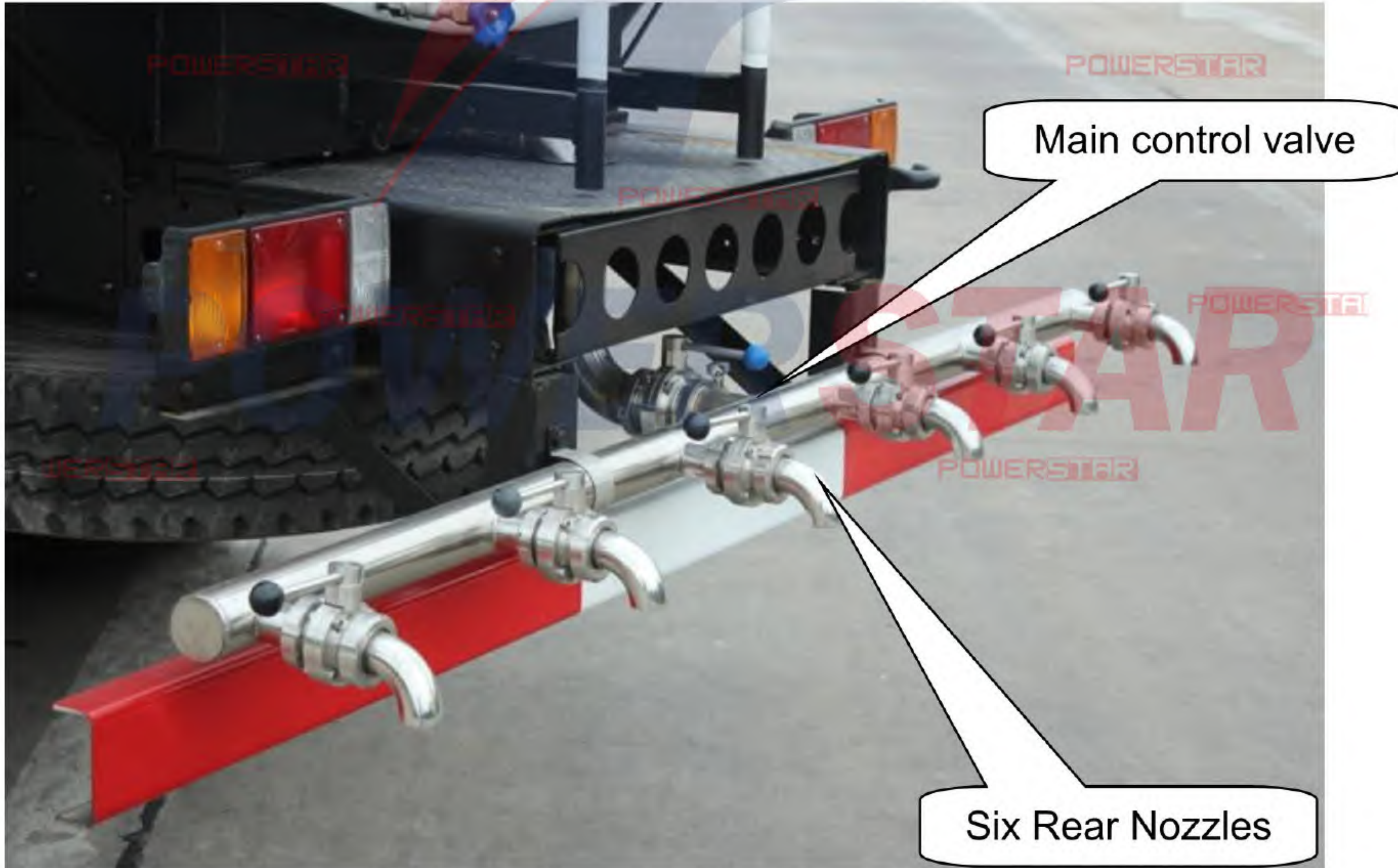

(Each nozzle working separately)



## Chapter 5, Others for Attention

After carefully reading the above information, you must be well known how to use the ISUZU 4\*2 Potable Water Truck; below show some parts you need to pay attention while using the truck.

### i ,Precautions for Use

- Please abide strictly by the following manual:
  1. *Potable Water Truck Owner's Manual*
- It is strictly forbidden to operate the pump without water. When the pump working over 2 minutes without water, you should stop the pump and carefully check everything and find the reason. (**Referring to Chapter 3**)
- It is strictly forbidden to operate the Power Take Off (PTO) under the condition of the clutch not separation (Not step the clutch pedal). When release the clutch, you should slowly.
- It is better not to do Half-Load transportation.
- When operating the Three-Way Valves (Valve A, B, C & others), it is not good to overexert, for overexert will influence the valve ball's leakproofness. The open & close for Three-Way Valves should completely, and strictly forbidden working when valves not operated completely.

### ii ,Regular Maintenance

- The maintenance of the Water Pump refer to the "*Potable Water Truck Owner's Manual*".
- When the temperature is below 0 °C, the storage water inside of the Pump, Pipeline and Tank should exhaust out to protect the parts from damage. If unused for a long time, please also exhaust out the water. When use truck again after long time, you should carefully check every parts.

- It should be checked all coupling and lubrication at fixed period to exclude the tight parts, and make sure all parts in good lubrication condition.
- The Water Pump, Sandwich PTO, PTO, Transmission Gearbox should be carefully washed, checked and maintenance every year.
- The strainer inside filter should be washed every time after use it.

### iii ,Truck Maintenance Schedule

- A. Frequent short-distance round trip
- B. Driving on rough roads
- C. Driving on dusty roads
- D. Driving in the cold season or on the salty road
- E. Overload driving for a long time

Item	Cycle	Condition				
		A	B	C	D	A+D
Engine Oil	Replace once every 7,500 km			✓		✓
Engine Oil Filter	Replace once every 7,500 km			✓		✓
Air Cleaner Element	Replace once every 10,000 km			✓		
Exhaust pipe and its mounting parts	Check once every 10,000 km	✓	✓		✓	
Transmission gear oil and differential oil	Replace once every 20,000 km		✓			
Grease for Cardan joint and sliding sleeve	Replace once every 10,000 km		✓			
Loose or damaged steering system	Check once every 5,000 km			✓	✓	
Steering kingpin	Check once every 5,000 km		✓	✓	✓	
Brake friction lining and Brake drum is worn	Check once every 10,000 km	✓	✓	✓		

Note: when engine oil volume is over the scale label MAX line, please change the engine oil